

ÉTAPE 1 - LA BASE

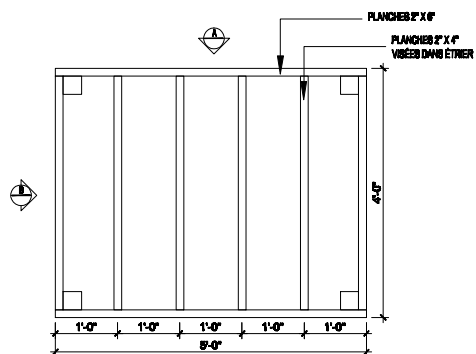

PLAN DE LA BASE
ÉCHELLE 1/2" = 1'-0"

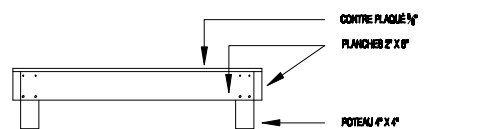

ÉLÉVATION B
ÉCHELLE 1/2" = 1'-0"

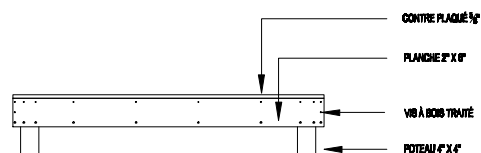

ÉLÉVATION A
ÉCHELLE 1/2" = 1'-0"

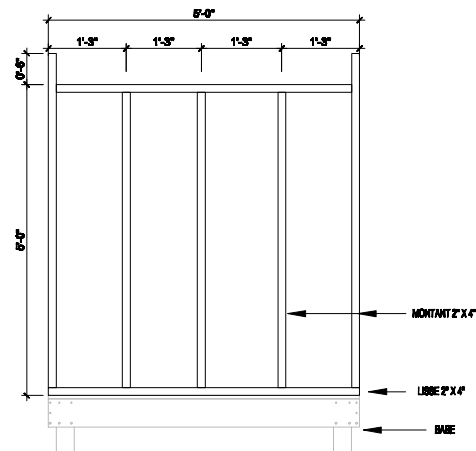

ÉLÉVATION MUR DE DERRIÈRE
ÉCHELLE 1/2" = 1'-0"

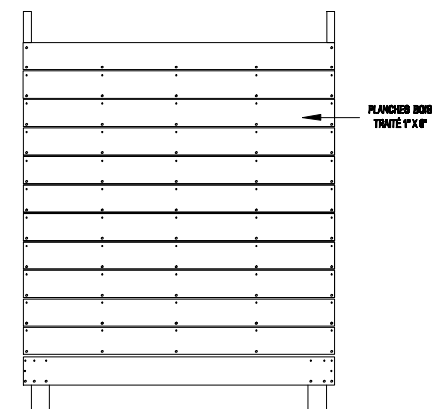

ÉLÉVATION MUR DE DERRIÈRE FINI
ÉCHELLE 1/2" = 1'-0"

ÉTAPE 2 - LES MURS

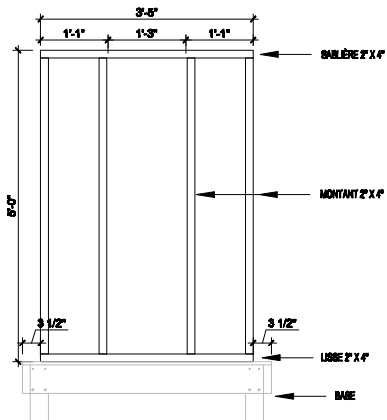

ÉLÉVATION 2 MURS LATÉRAUX
ÉCHELLE 1/2" = 1'-0"

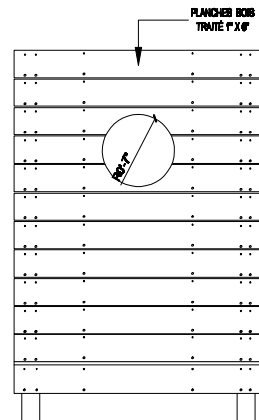

ÉLÉVATION 2 MURS LATÉRAUX FINIS
ÉCHELLE 1/2" = 1'-0"

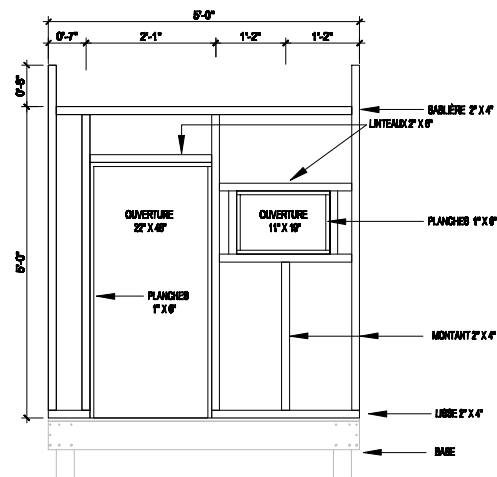

ÉLÉVATION DU MUR AVANT
ÉCHELLE 1/2" = 1'-0"

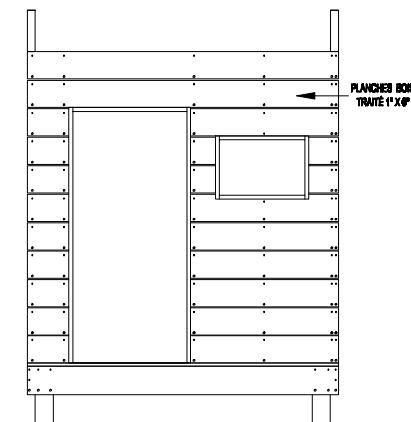

ÉLÉVATION MUR AVANT FINI
ÉCHELLE 1/2" = 1'-0"

 GROUPE BMR 1001, RUE HAMPDEN, SUITE 200, MONTRÉAL, QUÉBEC CANADA, H3B 2S7 TEL: 439-8646	NOM DU PROJET / PROJECT NAME: BÂTI COMME HUGO - CABANE ENFANT	NOM DU DÉTAILLÉ / DRAWING TITLE: LA BASE ET LES MURS
	DATE: 2021-05-07	PAGE: 1 DE 2

ÉTAPE 3 - LE TOIT

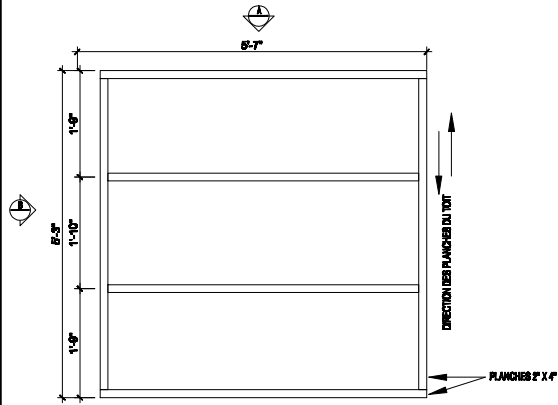

PLAN DU TOIT
ÉCHELLE 1/2" = 1'-0"

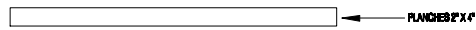

ÉLÉVATION A DU TOIT
ÉCHELLE 1/2" = 1'-0"

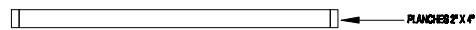

ÉLÉVATION B DU TOIT
ÉCHELLE 1/2" = 1'-0"

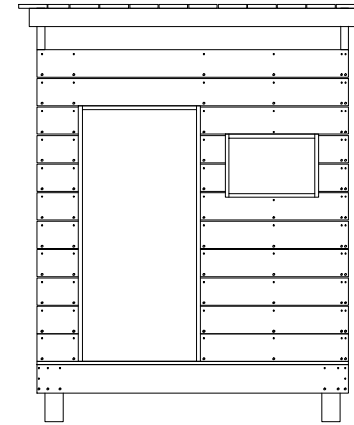

ÉLÉVATION CABANE ENFANT FINI
ÉCHELLE 1/2" = 1'-0"

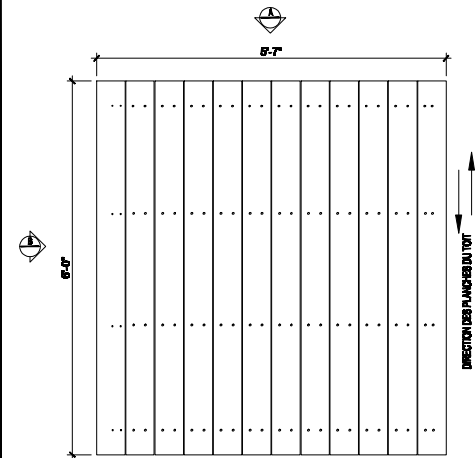

PLAN DU TOIT FINI
ÉCHELLE 1/2" = 1'-0"



ÉLÉVATION A DU TOIT FINI
ÉCHELLE 1/2" = 1'-0"



ÉLÉVATION B DU TOIT FINI
ÉCHELLE 1/2" = 1'-0"

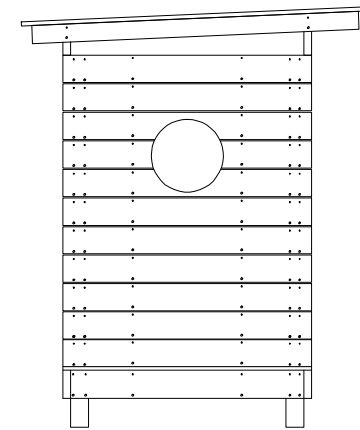

ÉLÉVATION CABANE ENFANT FINI
ÉCHELLE 1/2" = 1'-0"

 GROUPE BMR 1001, RUE MARCEL BOURGEOIS 985, MONTRÉAL, QUÉBEC CANADA, H3B 2Y7, TEL: 439-864-6966	NOM DU PROJET / PROJECT NAME: BÂTI COMME HUGO - CABANE ENFANT	NOM DU DESSIN / DRAWING TITLE: LE TOIT	DATE: 2021-05-07
	ÉCHELLE / SCALE: 1/2" = 1'-0"	PAGE: 2 DE 2 OF	