

ÉTAPE 1 - LE BÂTI

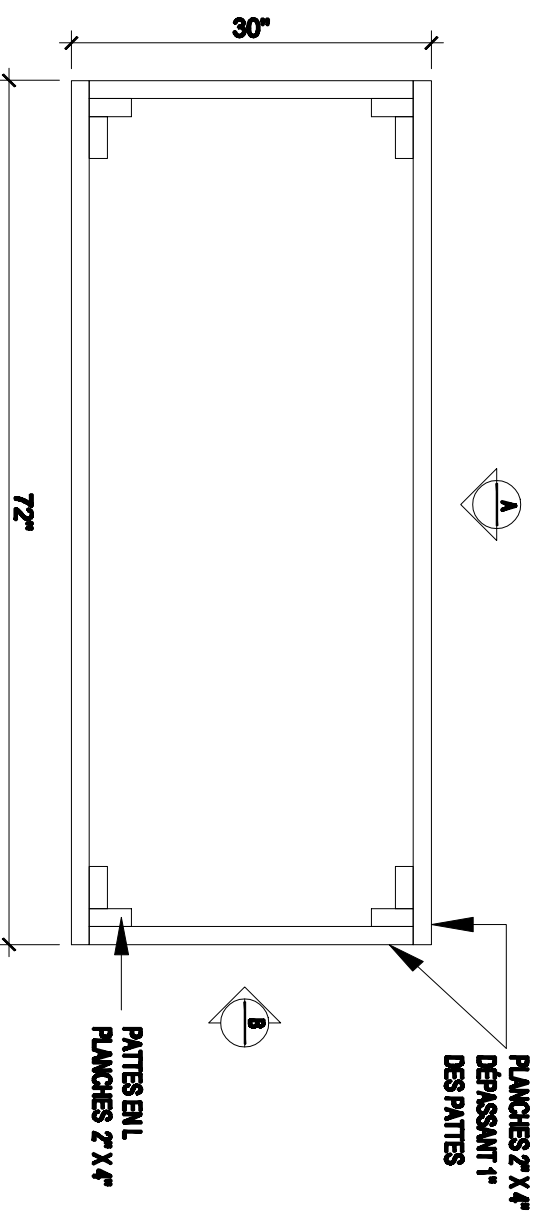

PLAN DE BASE DU BÂTI
ÉCHELLE 3/4" = 1'-0"

ÉTAPE 1 - LE BÂTI SUITE

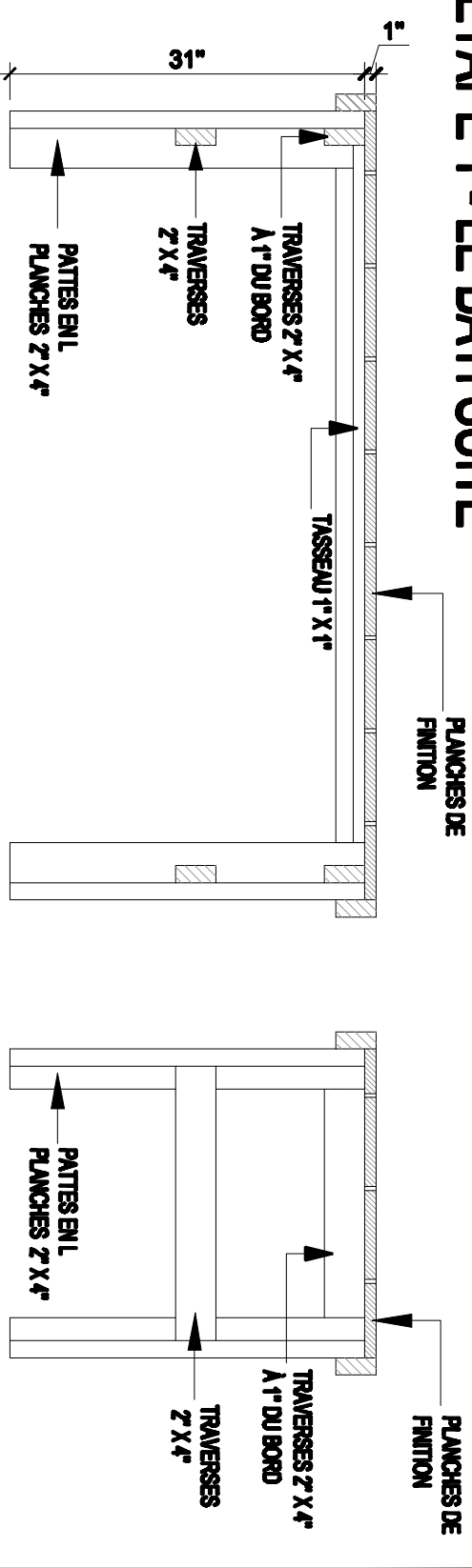

COUPE LONGITUDINALE
ÉCHELLE 3/4" = 1'-0"

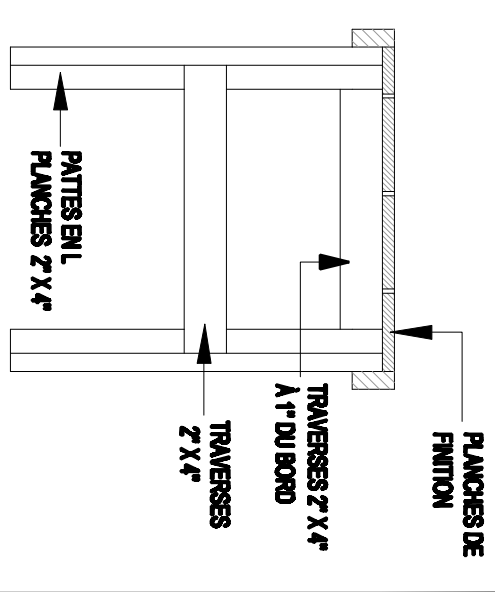

COUPE TRANSVERSALE
ÉCHELLE 3/4" = 1'-0"

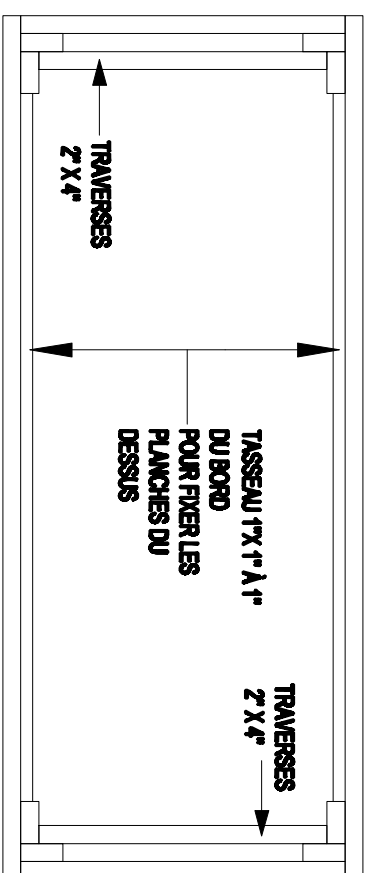

PLAN DE BASE
ÉCHELLE 3/4" = 1'-0"

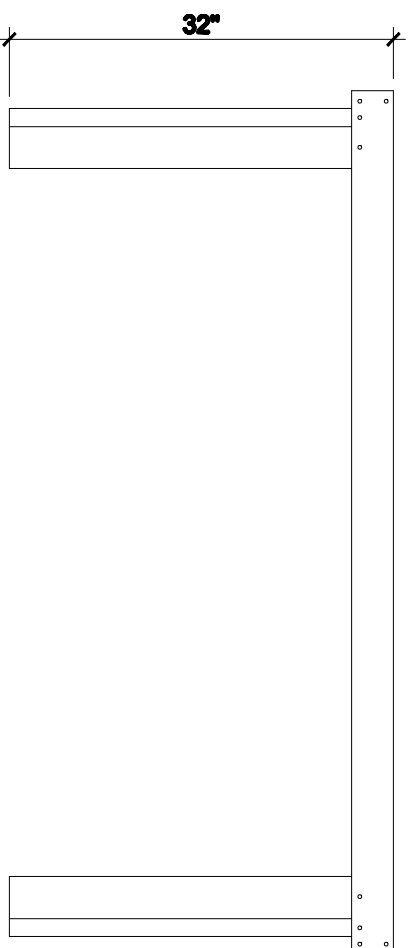

ÉLÉVATION A TABLE
ÉCHELLE 3/4" = 1'-0"

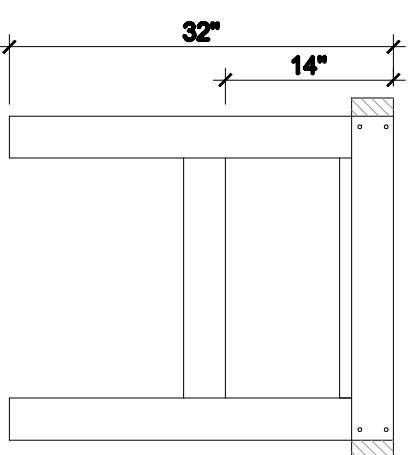

ÉLÉVATION B TABLE
ÉCHELLE 3/4" = 1'-0"

ÉTAPE 2 - LA FINITION

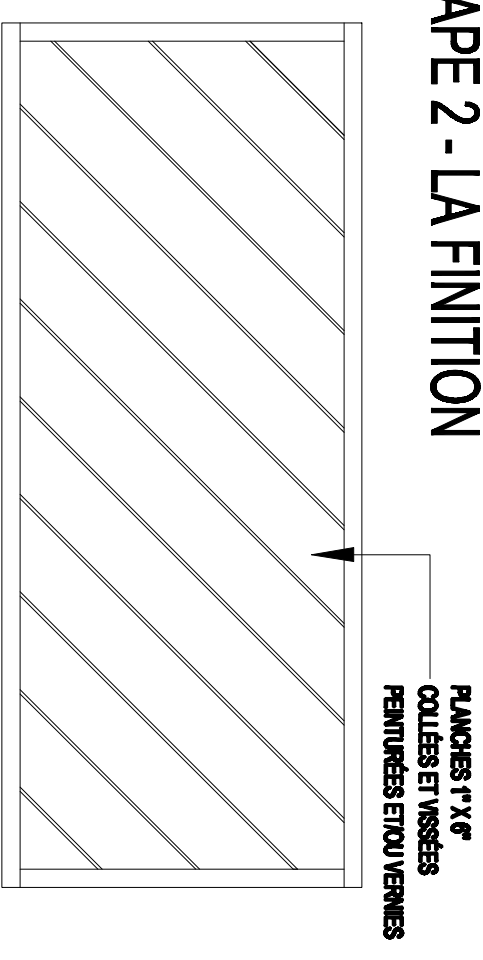

PLAN DESSUS DE LA TABLE FINIE
ÉCHELLE 3/4" = 1'-0"



LE NOUVEAU GROUPE BMR
1501, RUE ARMBRE, BUREAU 200, BOULDERVILLE, QUÉBEC
CANADA, H4B 6Z7 TEL: (454)857-8700

NOM DU PROJET / PROJECT NAME:

BÂTI COMME HUGO - TABLE

NOM DU DESSEIN / DRAWING NAME:

TABLE

DATE:

2021-07-14

ÉCHELLE:

3/4" = 1'-0"

PAGE:

1